

Operating instructions

**Heatable Reflector for
Optical Anti-Collision Devices
Type 8R100BLH**

E_68032.pdf

Features

- ✓ Clearance distance up to 35 m
- ✓ High performance in terms of detection
- ✓ Safe mounting of reflectors

Functionalities

- Collision protection
- Distance monitoring

ONLY for cranes that run on a common crane track or rail.

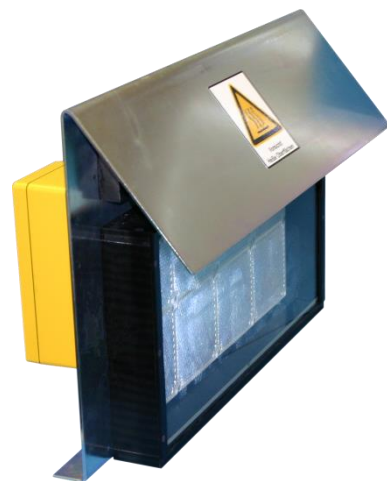

R Revision index: 2019-11
Revision date: 15.01.2019
Processed by: tb/mp



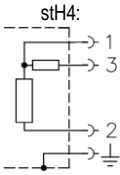
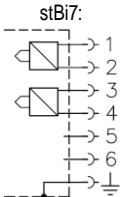

Table of Contents

1. Identification / General Remarks	3
1.1 <i>Product versions / Plates representations</i>	3
1.2 <i>Name and address of the manufacturer</i>	3
1.3 <i>Definition of symbols:</i>	3
2. Product description	4
2.1 <i>Product mark</i>	4
2.2 <i>Intended use, general function and area of application</i>	4
2.3 <i>Incorrect use and foreseeable misuse</i>	4
2.4 <i>Safety information</i>	5
3. Definitions – technical data	6
4. Operating instructions	6
4.1 <i>Information on this technical description</i>	6
4.2 <i>Device description</i>	6
4.3 <i>Information on assembly</i>	7
4.4 <i>Electrical connection</i>	7
4.4.1 <i>General</i>	7
4.4.2 <i>Terminal diagram</i>	8
4.4.3 <i>Necessary on-site wiring system for programmable logic controllers (PLC) with internal relay contacts</i>	9
4.4.4 <i>Necessary on-site wiring system for programmable logic controllers (PLC) with external relays or contactors</i>	10
4.5 <i>Requirements on the programmable logic controller (PLC)</i>	11
4.5.1 <i>General requirements on the PLC</i>	11
4.5.2 <i>Program requests to the PLC:</i>	11
4.5.3 <i>Calculation of the heating pane surface temperature</i>	13
5. Applicable documents	14
6. Maintenance and cleaning	14
7. Decommissioning	15
8. Spare parts	15

1. Identification / General Remarks

1.1 Product versions / Plates representations



8R100BLH

Typ Type Seriennummer Serial number Baujahr Year of manufacture Versorgung Supply Schutzart Protection mode Anschluss Connection	<p>8R100BLH</p> <p>24VDC/~4A</p> <p>IP65</p>	 
	<p>stH4:</p>  <p>Kl. / Term. 1: +24VDC Kl. / Term. 2: 0V Kl. / Term. 3: Teilleistung / partial power Kl. / Term. PE: PE</p>	<p>stBi7:</p>  <p>Temperaturüberwachung 1 / temperature monitoring output 1: Kl. / Term. 1: + 4...20mA Kl. / Term. 2: - 4...20mA Temperaturüberwachung 2 / temperature monitoring output 2: Kl. / Term. 3: + 4...20mA Kl. / Term. 4: - 4...20mA Kl. / Term. 5 & 6: nc.</p>
		<p>Fotoelektrik Pauly 59368 Werne / Germany www.pauly-lichtschranken.de</p> 

1.2 Name and address of the manufacturer

Fotoelektrik Pauly GmbH
Wahrbrink 6
59368 Werne, Germany

1.3 Definition of symbols:

	<p>Must follow – Critical information</p> <p>This symbol describes safety warning of dangerous situations and indicates necessary measures and / or appropriate precautionary measures.</p> <p>Failure to comply can result in death or property damage.</p>
	<p>Must know – Important information</p> <p>This symbol describes e.g. situations that could damage the product or devices in its vicinity, and accordingly provide appropriate action.</p> <p>The sign identifies particularly important passages.</p>

2. Product description

2.1 Product mark

8R100BLH: Heatable large-area high performance reflector for distance monitoring tasks using the triangulation method.

2.2 Intended use, general function and area of application

Acknowledgement of the contents of these operating instructions forms part of the intended use. Notes and safety information should be observed in particular.

For the structure and the function of the complete distancing setup, the operating instructions applicable for that are to be additionally considered.

The employment of the distancing devices, together with the heatable reflector 8R100BLH, is suitable for exterior applications.

The monitoring and regulation of the reflector heating through a programmable logic controller described in Section 4.5 are prerequisites for utilization according to specification.

The reflector heating minimizes the influence of moisture condensation and freezing wetness on the effective reflector surface.

The reflector heating is controlled by a programmable logic controller (PLC on site), dependent on the outside temperature.

2.3 Incorrect use and foreseeable misuse

It is not permissible to use the device in any manner that deviates from the technical data description or operate it outside the prescribed areas of application.

The heatable reflector 8R100BLH is not suitable for operation in

- areas with significant challenging environmental requirements (e. g. potentially explosive areas).
- areas of excessive pollution influence where a proper function may not be ensured, despite regular cleaning of the optical elements.
- applications where normal operation due to excessive steam, fog or smoke cannot be guaranteed.

Any technical alterations will result in cancellation of the product warranty!

2.4 Safety information



System-related movement tolerances of crane system components and the possible associated effects on the switching behavior of the distance monitoring system must be taken into consideration when planning crane systems.



A correct assembly and alignment of the system are essential for the correct operation of the system's function.



The set clearance distance could be reduced, e.g. by fog, steam, smoke, snowfall or rain. During limited vision, e.g. caused by fog or steam, the function of the distance monitoring system must be checked.



The light beam on the system must not be interrupted, for example by obstructions or suspended objects. It is essential that proper attention is paid to this during assembly and operation of the system.



Before commencement of work, the system's function must be checked by moving the cranes together (daily functional check).



The installation of the light barriers may only be performed by authorized technical personnel who have the requisite professional expertise to install electrical devices on crane systems.



The device must be immediately taken out of operation in the event of damage or leaks in the housing, cable or line entries.



Requirements resulting from provisions relating to cranes must be applied under all circumstances.



Safety mechanisms may not be bridged without the implementation of appropriate, equivalent measures.



The operator/installer must be aware and comply to the information that applies to his area of deployment; this also applies to the product, cables and lines installation



Further or supplementary protective measures may be required on the basis of risk assessments for special areas of application.



If the device is operated in conjunction with other components such as control systems or sensors, the corresponding user instructions must be heeded.

3. Definitions – technical data

	8R100BLH
Maximum clearance distance	35 m with PP(PV)1037 respectively PP(PV)1038 15 m with PP(PV)1037*01 respectively PP(PV)1038*04
Power supply / output or current consumption	24VDC ± 10 % / ~ 4A (reduced heating power: ~ 1,8A)
Connection	
<i>Power supply</i>	3 + 1 pin plug stH4
<i>Monitoring outputs</i>	6 + 1 pin plug stBi7
Output	2x current output 4...20mA
Operating indicator	LED green
Housing	Steel (chromate coating), POM, AL-cast, glass
Protection mode	IP65 – protection against dust and jets of water
Weight	~ 13,5 kg
Operating temperature	- 20 °C ... + 60 °C, non-condensing
Permitted wind speed	Please contact the manufacturer in case of lager wind speeds

4. Operating instructions

4.1 Information on this technical description

These operating instructions contain information on the correct and effective use of the heatable reflector 8R100BLH. They constitute a component of the scope of delivery.











4.2 Device description

The heatable reflector 8R100BLH is a component part of a distancing system or collision protection system, consisting of a reflex light barrier and this reflector. The setting adjustment of the distancing separation is implemented according to the triangulation principle.

In the case of the heatable reflector 8R100BLH, a flat-structured heating element is assembled before the active reflector surface. The two-stage heating element is controlled by a programmable logic controller (PLC) and, dependent on the outside temperature, is heated up to such an extent that moisture condensation and freezing wetness are effectively suppressed.

The programmable logic controller (PLC) starts the heating control according to the specifications described under Section 4.5, where the relay/contactors and 4...20mA outputs of the heatable reflector are evaluated and monitored. If all signals are in the necessary range, the crane drive is released, otherwise a fault causes the stopping of the crane drive and a corresponding verification of the system.



4.3 Information on assembly

-  The operating instructions of the distancing assembly are to be considered in addition.
-  The reflector must be installed in non-accessible areas or must be concealed
-  The reflector is to be mounted near the parapet edge. The "delivery" of the visible surface of the reflector is to be avoided absolutely.
-  The light beam of the system must not be interrupted e.g. obstructions or suspended objects. This must be taken into account at all events during assembly and operation of the system.
-  It is to be absolutely ensured that the optics of the distancing assembly still has a reflector view if both cranes have driven together to buffer separation distance!
-  The set clearance distance must be tested and recorded.
-  The reflector should be protected from pollution by suitable measures e.g. a protective housing.
-  The reflector center on the other crane must be situated at the optical device (lens) level.
-  Assembly may only be performed by a trained professional.
-  The installation of the reflector and the light barrier, and also the alignment of the triangulation triangle, may be implemented horizontally only.

4.4 Electrical connection

4.4.1 General

The wiring system according to one of the specified wiring diagrams must be implemented on site according to the valid standards

-  The wiring system according to one of the wiring diagrams specified under Section 4.4.3 and 4.4.4 is obligatory and decisive for the function.
-  The external voltage supply should correspond to the specifications for safety extra-low voltage (SELV) or protected extra-low voltage (PELV) in accordance with EN 60204-1
-  Note on the wiring system:
The circuit is to be fuse protected with a 6 A fuse.

4.4.2 Terminal diagram

The electrical connection is represented below. The supply voltage is to be provided according to the rating plate.

Table 4.4.2a

Connector pin assignment stH4	
Pin 1	DC supply: + 24 V
Pin 2	DC supply: 0 V
Pin 3	Reduced heating power input
	PE (protective earth)

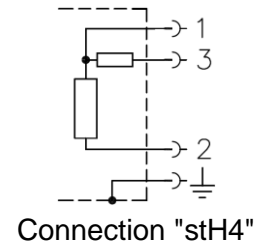
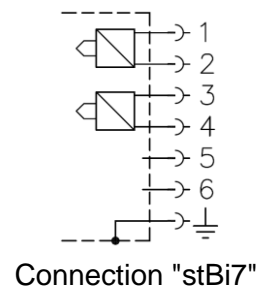

Table 4.4.2b

Connector pin assignment stBi7	
Pin 1	+ 4...20 mA output
Pin 2	- Temperature monitoring 1
Pin 3	+ 4...20 mA output
Pin 4	- Temperature monitoring 2
Pin 5	nc.
Pin 6	nc.
	PE (protective earth)



Fotoelektrik Pauly – Light barriers

4.4.3 Necessary on-site wiring system for programmable logic controllers (PLC) with internal relay contacts

Wiring diagram 1 for programmable logic controllers (PLC) with sufficiently powerful and internal relay contacts:

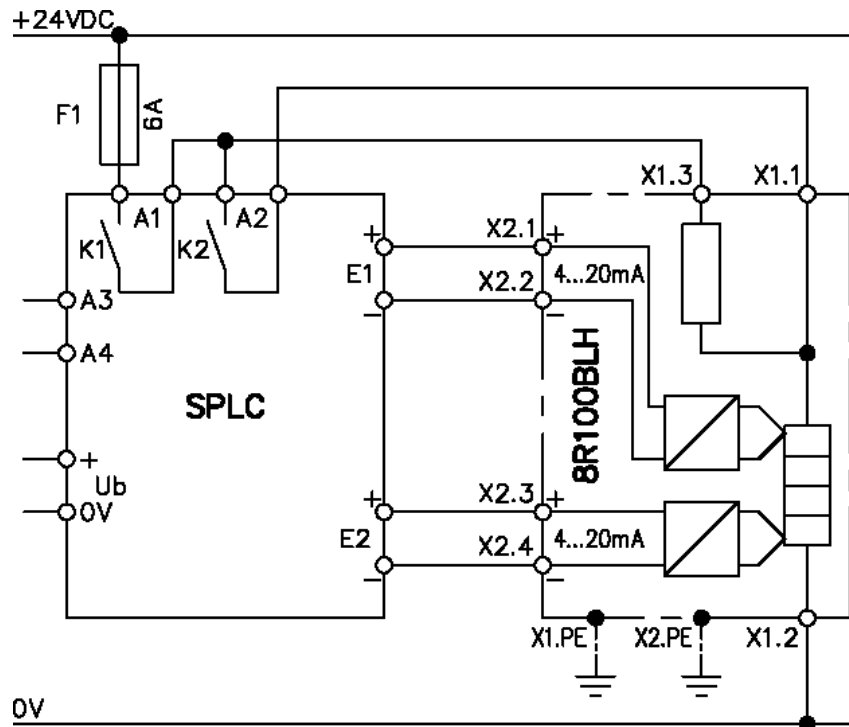





Illustration 4.4.3

-  The wiring system according to one of the wiring diagrams specified under Section 4.4.3 and 4.4.4 is obligatory and decisive for the function.
-  Only possible if the PLC is equipped with sufficiently-powerful internal switching outputs (A1 & A2).
-  The outputs A3 and A4 of the PLC are used for the crane release.

Fotoelektrik Pauly – Light barriers

4.4.4 Necessary on-site wiring system for programmable logic controllers (PLC) with external relays or contactors

Wiring diagram 2 for programmable logic controllers (PLC) with external relays or contactors:

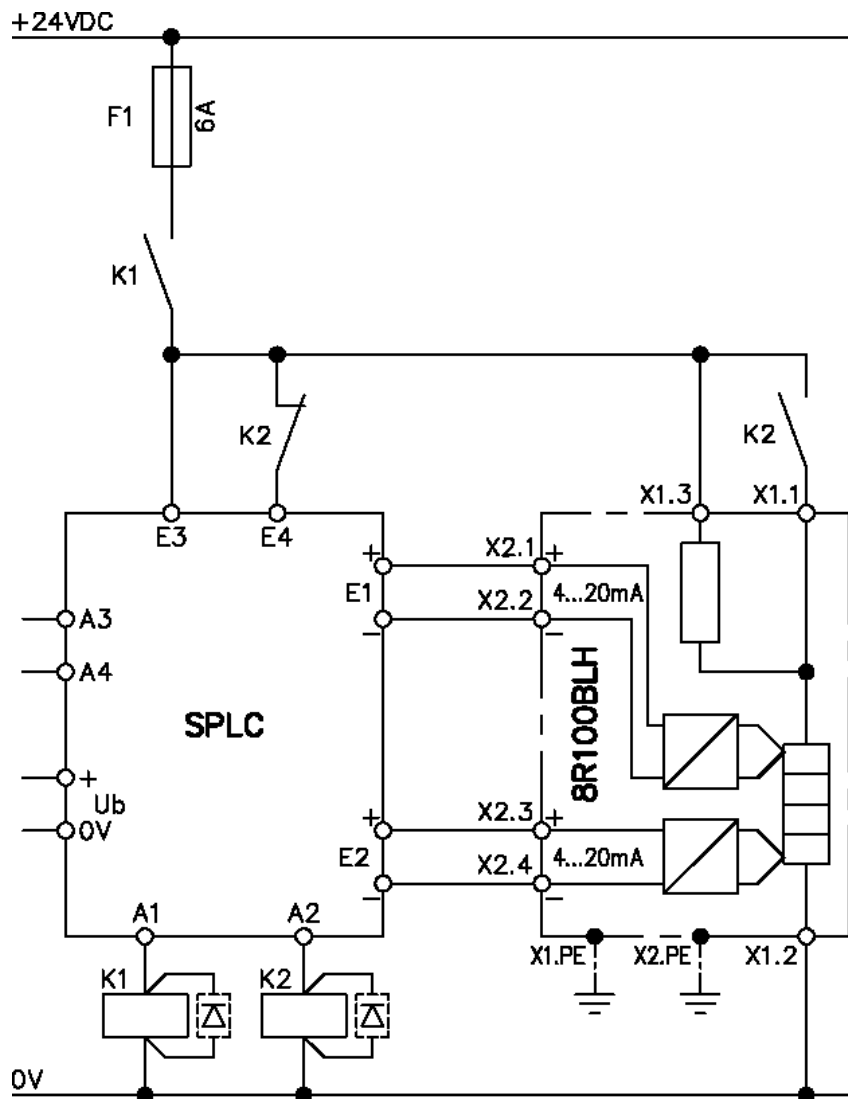





Illustration 4.4.4

-  The wiring system according to one of the wiring diagrams specified under section 4.4.3 and 4.4.4 is obligatory and decisive for the function.
-  The outputs A3 and A4 of the PLC are used for the crane release.
-  The relays and contactors K1 and K2 must be connected in parallel with the reactance coil, with a corresponding spark-suppressing element in each case, e.g. a flyback diode.

4.5 Requirements on the programmable logic controller (PLC)

4.5.1 General requirements on the PLC

The following tasks must be taken over by the programmable logic controller (PLC):

- Heating control in accordance with specifications designated further below
- Monitoring of all components of the heating, thus the reflector, the relay/contactor and the cabling.
- Release of the crane drive.

Only when all components are functional and all signals are in the necessary range may the crane drive be released, otherwise a fault determines the stopping of the crane drive and, where appropriate, a corresponding signal for the verification or operational shutdown of the system.

4.5.2 Program requests to the PLC:

The following requirements are set on the application program of the programmable logic controller (PLC):

The crane release may be implemented only if each of the following conditions is fulfilled:

- The contactor/relay K1 and the corresponding output A1 of the PLC works fault-free.
- The contactor/relay K2 and the corresponding output A2 of the PLC works fault-free.
- Both analog outputs of the reflector give values of temperature corresponding to at least +12°C.
- Both analog outputs of the reflector give values of temperature corresponding to maximum +70°C.
- The difference of both analog outputs of the reflector is a value corresponding to temperature of maximum 10 K

The regulation of the reflector heating over the PLC must be structured in the following way:

- At least one of the two analogue outputs of the reflector gives a value corresponding to a temperature below +18°C
→ Switch on contactor/relay K1
- At least one of the two analogue outputs of the reflector gives a value corresponding to a temperature below +18°C and the contactor/relay K1 is switched on
→ Switch on contactor/relay K2 (note 1)
- At least one of the two analogue outputs of the reflector gives a value corresponding to a temperature above +65°C (note 2)
→ Switch off contactor/relay K2
- At least one of the two analogue outputs of the reflector gives a value corresponding to a temperature above +65°C (note 2) and the contactor/relay K2 is switched off
→ Switch off contactor/relay K1 (note 1)

Table 4.5.2

Regulation of the reflector heating over the PLC				
Contactor/Relay status		Reflector surface temperature	Action	
K1	K2		K1	K2
Off	Off	Sinks below +18°C	Switch on	-
On	Off	Sinks below +18°C	-	Switch on (note 1)
On	On	Rises above +65°C (note 2)	-	Switch off
On	Off	Rises above +65°C (note 2)	Switch off (note 1)	-

Note 1:

In the application program for the regulation of the reflector heating, a short time-related hysteresis is necessary because of the thermal inertia and the same switching point between the switching on of the K1 and the switching on of the K2. The same applies between the switching off of the K2 and the switching off of the K1.

Note 2:

Switching point 65°C: Active protection against combustion on the heating pane.

The following faults determine a signal of the PLC for the verification of the components:

- Contactor/Relay K1 and corresponding PLC input/output works incorrectly
→ Verification of the wiring system and the component required.
- Contactor/relay K2 and corresponding PLC input/output works incorrectly
→ Verification of the wiring system and the component required.
- After the heating-up phase (*) a thermosensor measures a value corresponding to a temperature below +12°C
→ Verification of the wiring system, the component part and the environmental conditions required.
- A temperature difference corresponding to more than 10 K exists between both thermosensors
→ Verification of the component and the environmental conditions required.
- At least one of the two instrument transformer outputs a current below 4 mA
→ Verification of the wiring system and the component required.

(*): After switching on the reflector heating with low ambient temperatures, thus below 12°C, a programmed heating-up phase of the heating pane of at least 2...3 minutes must be planned. In this heating-up phase, the crane drive may not be released, the error report can appear here as suppressed or reduced.

The following faults determine a signal of the PLC for the operational shutdown of the reflector and for verification:

- At least one thermosensor/instrument transformer measures above +70°C
→ Operational shutdown of the reflector, in addition verification of the wiring system, the construction part and the environmental conditions required.
- At least one thermosensor/instrument transformer outputs a current of 23 mA.
→ Operational shutdown of the reflector.

4.5.3 Calculation of the heating pane surface temperature

Remark on the following calculations and ref. the following table:

- In case of heating pane surface temperatures lower than or equal to -10°C , an output current of 4 mA is set on the thermosensor instrument transformer
- In case of heating pane surface temperatures greater than or equal to $+80^{\circ}\text{C}$, an output current of 20 mA is set at the thermosensor instrument transformer

Calculation of the output current I_a over the heating pane surface temperature ϑ_H :

$$I_a = \left(4\text{mA} + \frac{(\vartheta_H - (-10^{\circ}\text{C})) \times 16\text{mA}}{90^{\circ}\text{C}} \right) [\text{mA}]$$

Example: $\vartheta_H = 65^{\circ}\text{C}$

$$I_a = 4\text{mA} + \frac{(65^{\circ}\text{C} - (-10^{\circ}\text{C})) \times 16\text{mA}}{90^{\circ}\text{C}} = 17,333\text{mA}$$

Calculation of the heating pane surface temperature ϑ_H over the output current I_a :

$$\vartheta_H = \left((-10^{\circ}\text{C}) + \frac{(I_a - 4\text{mA}) \times 90^{\circ}\text{C}}{16\text{mA}} \right) [^{\circ}\text{C}]$$

Example: $I_a = 8.978 \text{ mA}$

$$\vartheta_H = (-10^{\circ}\text{C}) + \frac{(8,978\text{mA} - 4\text{mA}) \times 90^{\circ}\text{C}}{16\text{mA}} = +18^{\circ}\text{C}$$

Table 4.5.3: Heating pane surface temperature ϑ_H [$^{\circ}\text{C}$] to output current I_a [mA]

$^{\circ}\text{C}$	x0	x1	x2	x3	x4	x5	x6	x7	x8	x9
-1x	4,000	4,000	4,000	4,000	4,000	4,000	4,000	4,000	4,000	4,000
-0x	5,778	5,600	5,422	5,244	5,067	4,889	4,711	4,533	4,356	4,178
+0x	5,778	5,956	6,133	6,311	6,489	6,667	6,844	7,022	7,200	7,378
+1x	7,556	7,733	7,911	8,089	8,267	8,444	8,622	8,800	8,978	9,156
+2x	9,333	9,511	9,689	9,867	10,044	10,222	10,400	10,578	10,756	10,933
+3x	11,111	11,289	11,467	11,644	11,822	12,000	12,178	12,356	12,533	12,711
+4x	12,889	13,067	13,244	13,422	13,600	13,778	13,956	14,133	14,311	14,489
+5x	14,667	14,844	15,022	15,200	15,378	15,556	15,733	15,911	16,089	16,267
+6x	16,444	16,622	16,800	16,978	17,156	17,333	17,511	17,689	17,867	18,044
+7x	18,222	18,400	18,578	18,756	18,933	19,111	19,289	19,467	19,644	19,822
+8x	20,000	20,000	20,000	20,000	20,000	20,000	20,000	20,000	20,000	20,000

Example:

Output current I_a at $\vartheta_H = +18^{\circ}\text{C}$? → Line "+1x", Column x8 → output current $I_a = 8.978 \text{ mA}$

Output current I_a at $\vartheta_H = +65^{\circ}\text{C}$? → Line "+6x", Column x5 → output current $I_a = 17.333 \text{ mA}$

5. Applicable documents

Table 5

Indenture number	Model	Document type	Description	Document
6803	8R100BLH	Data sheet	Heatable reflector for 35/15 m distance	E_68031.pdf
6803	8R100BLH	Operating instructions	This document	E_68032.pdf

6. Maintenance and cleaning

The optical surfaces and inspection of limit distances should only be performed by qualified technical personnel.

- a. Depending on the amount of pollutants e.g. dust accumulation in the system, the function and the set clearance distance of the system must be checked by moving the cranes together. The inspection interval depends on the expected degree of pollution. A suitable time interval for regular checking must be determined by the user and must be strictly adhered to. The minimum requirement is the functional check at the start of work to check the system's function by moving the cranes together (daily functional check, see section 2.4)
- b. Depending on the amount of pollution occurring in the system, the optical surfaces of the distancing device has to be cleaned in the fixed time interval (see "a")
In addition to the reflector the optical surfaces also include the lenses of the device.
- c. In the case of outdoor applications measures must be taken to prevent dew collecting or ice forming on the reflector.

A soft, fluff-free cloth moistened with water should be used for cleaning. If required, a very small quantity of conventional washing-up liquid can be added to the clean water.



Do not use any cleaning agents containing alcohol or other solvents because they can ruin the function!



Avoid scratching the lens and reflectors.

A functional test should be carried out on the distance monitoring system after each cleaning procedure. This should include a check of the disconnection function at the fixed limit distances. If necessary, the distance monitoring system should be reset to the fixed limit distances.

7. Decommissioning

The device must be correctly disposed of at the end of its service life. When decommissioning please observe the local laws on the disposal of electronic equipment.

8. Spare parts

Table 8

Indenture number	Model	Description	Power supply
6803	8R100BLH	Heatable reflector for 35/15 m distance	24VDC

Order data:

Model

Example:

8R100BLH /24VDC

59368 Werne, 2019-01-15

* 6803 GE *

SRC: E_68032-2019-11.docx

Fotoelektrik Pauly GmbH

The ownership and design of devices and their electronics are the intellectual property of "Firma Fotoelektrik Pauly GmbH". Internal wiring diagrams can therefore not be provided for copyright reasons. Subject to technical changes and errors. Reproductions or copies of excerpts of this document are only permitted with the approval of "Firma Fotoelektrik Pauly GmbH" and with specification of the source. Infringements shall be liable to prosecution.