

Operating Instructions

Optical Anti-Collision Device

Type CPV1037

E_52592.pdf

Features	Functionalities
<ul style="list-style-type: none"> ✓ Cat. 2, PL=c, SIL 1 in acc. with EN ISO 13849 and EN 62061 ✓ Clearance distance of up to 50 m ✓ High performance in terms of detection ✓ Pollution warning/ Anti Sabotage system ✓ Integrated test system – a highly dynamic process reproduces the light reflected by the reflector ✓ Safe mounting of reflectors 	<ul style="list-style-type: none"> ○ Collision protection ○ Distance monitoring <p>Only for cranes that run on a common crane track or rail.</p>
	

Revision index: 2020-30
 Revision date: 19.02.2020
 Processed by: tb



Table of Contents



1. Identification / General Remarks	3
1.1 Product versions / Plates representation	3
1.2 Name and address of the manufacturer	3
1.3 Applied standards and technical specifications:	4
1.4 Definition of symbols:	4
2. Product description	4
2.1 Product mark	4
2.2 Intended use, general function and area of application	5
2.3 Incorrect use and foreseeable misuse	5
2.4 Safety information	6
3. Definitions – technical data	7
4. Operating instructions	9
4.1 Information on this technical description	9
4.2 Device description	9
4.3 Description of function	10
4.3.1 Triangulation triangle	10
4.3.2 Approach movement	10
4.3.3 Continually self-testing	11
4.3.4 Possible movement of the crane	11
4.3.5 Movement of the crane is stopped	11
4.4 Pollution control function	12
4.4.1 Principle	12
4.4.2 Pollution example	12
4.4.3 Pollution Indicator – meaning of the different circuit states	13
4.5 Assembly	14
4.5.1 Horizontal arrangement of the triangulation triangle	14
4.5.2 Distance monitoring accuracy	15
4.5.3 Taking the tolerances into consideration with respect to clearance distance	16
4.6 Information on assembly	17
4.7 Adjustment using the “light beam method”	18
4.8 Electrical connection	19
4.9 Applicable documents	20
5. Maintenance and cleaning	20
6. Contents of the EU Declaration of Conformity	21
7. Decommissioning	22
8. Spare parts	22

1. Identification / General Remarks

1.1 Product versions / Plates representation

CPV1037
CPV1037*01

Bezeichnung General description	Optical Anti-Collision Device				CE 0393
Typ Type	CPV1037 <small>CPV1037 /R/2M20/... 5259x...</small>				
Seriennummer Serial number					
Baujahr Year of manufacture					
Reichweite Range	0,5...25/50m			Fotoelektrik Pauly 59368 Werne / Germany www.fotoelektrik-pauly.de	
Versorgung Supply					
Schutzart Protection mode	IP65				
Reaktionszeit Response time	80ms				
Bescheinigungsnummer Certificate number	HSM 09 079				
Sicherheits-Integritätslevel Safety Integrity Level	1	<small>gemäß DIN EN 62061 according to DIN EN 62061</small>			
Sicherheitskategorie Safety category	2	C	88 <small>MTTF_a [a]</small>	<small>gemäß DIN EN ISO 13849-1 according to DIN EN ISO 13849 -1</small>	

Bezeichnung General description	Optical Anti-Collision Device				CE 0393
Typ Type	CPV1037*01 <small>CPV1037*01 /R/2M20/... 5259M01x...</small>				
Seriennummer Serial number					
Baujahr Year of manufacture					
Reichweite Range	1...25m			Fotoelektrik Pauly 59368 Werne / Germany www.fotoelektrik-pauly.de	
Versorgung Supply					
Schutzart Protection mode	IP65				
Reaktionszeit Response time	80ms				
Bescheinigungsnummer Certificate number	HSM 09 079				
Sicherheits-Integritätslevel Safety Integrity Level	1	<small>gemäß DIN EN 62061 according to DIN EN 62061</small>			
Sicherheitskategorie Safety category	2	C	88 <small>MTTF_a [a]</small>	<small>gemäß DIN EN ISO 13849-1 according to DIN EN ISO 13849 -1</small>	



1.2 Name and address of the manufacturer

Fotoelektrik Pauly GmbH
Wahrbrink 6
59368 Werne, Germany

1.3 Applied standards and technical specifications:

EN ISO 13849	Safety of machinery – Safety-Related Parts of Control Systems
EN 62061	Safety of machinery - Functional safety of safety-related electrical, electronic and programmable electronic control systems

1.4 Definition of symbols:

	Must follow – Critical information This symbol describes safety warning of dangerous situations and indicates necessary measures and / or appropriate precautionary measures. Failure to comply can result in death or property damage.
	Must know – Important information This symbol describes e.g. situations that could damage the product or devices in its vicinity, and accordingly provide appropriate action. The sign identifies particularly important passages.

2. Product description

2.1 Product mark

CPV1037 and CPV1037*01: high performance reflex light barriers for distance monitoring tasks using the triangulation method.

2.2 Intended use, general function and area of application

Acknowledgement of the contents of these operating instructions forms part of the intended use. Notes and safety information must be observed in particular.

The Model CPV1037 System is

- a mechanism for collision protection and distance monitoring exclusively for cranes that run on a common crane track. The reflector centre on the other crane must be situated at the optical device (lens) level.
- intended for use in weatherproof applications where the direct influence of the weather is prevented
- exclusively intended for use in machinery within the meaning of the scope of EN 60204-32 (Electrical Equipment of Cranes), EN 15011 (Bridge and gantry cranes) and also EN 12077-2 (Limiting devices).

When used as collision protection device, the moving crane is prevented from colliding e.g. brought to a standstill in reference to the other crane (opposite crane).

When used as a distance monitoring device, a risk triggering approach of cranes is detected.

At least one device is required for each crane and the corresponding reflector is positioned at the opposite wall/crane.

2.3 Incorrect use and foreseeable misuse















It is not permissible to use the device in any manner that deviates from the contents of the operating instructions or operate it outside the prescribed areas of application.

The CPV1037 System is not suitable for operation in

- areas with significant environmental challenging requirements (e.g. potentially explosive areas).
- areas of excessive pollution influences where a proper function may not be ensured, despite regular cleaning of the optical elements.
- applications where normal operation due to excessive fog, excessive steam or excessive smoke cannot be guaranteed.
- systems where disconnecting the current does not lead to a safe mode.
- collision protection and distance monitoring for cranes which run on a curved crane/rail track.
- collision protection and distance monitoring for cranes which do not run on a common crane/rail track.
- collision protection of e.g. Industrial trucks or similar transport equipment.
- use without reflector (please refer section 3).

Any technical alterations will result in cancellation of the product warranty!

2.4 Safety information

-  **System-related movement tolerances of crane system components and the possible associated effects on the switching behaviour of the distance monitoring system must be taken into consideration when planning crane systems.**
-  **A correct assembly and alignment of the system are essential for the correct operation of the system's safety function.**
-  **The set clearance distance could be reduced, e.g. by fog, steam or smoke. During limited vision, e.g. caused by fog, steam or smoke, the function of the distance monitoring system must be checked by moving the cranes together.**
-  **The light beam on the system must not be interrupted, for example by obstructions or suspended objects. It is essential that proper attention is paid to this during assembly and operation of the system.**
-  **Before commencement of work, the system's safety function must be checked by moving the cranes together (daily functional check).**
-  **The installation of the light barriers may only be performed by authorized technical personnel who have the requisite professional expertise to install electrical devices on crane systems.**
-  **The device must be immediately taken out of operation in the event of damage or leaks in the housing, cable or line entries.**
-  **Requirements resulting from provisions relating to cranes must be applied under all circumstances.**
-  **All different components with safety functions must be taken into account of the safety parameters (PL, PFH_d, MTTF_d), e.g. an optionally required additional external power supply or output side follow-up circuit.**
-  **Further or supplementary protective measures may be required on the basis of risk assessments for special areas of application, e.g. restart inhibit. According to EN ISO 13849, an automatic restart may only take place, if no hazardous situation exists.**
-  **The distancing system may not be bridged.**
-  **The crane operator and/or the crane manufacturer must be aware and comply to the information that applies to his area of deployment; this also applies to the product, cables and lines installation**
-  **If condensation on the reflector surface cannot be excluded for an application with high air humidity or/and abrupt change in temperature then an anti-fogging coated reflector version must be used. A suitable reflector type will be model 4R100BLAF or model 18R100BLAF (see catalog of applicable documents in section 4.9).**
-  **If the device is operated in conjunction with other components such as control systems or sensors, the corresponding user instructions must be heeded.**

3. Definitions – technical data

	CPV1037	CPV1037*01
Certificate no.	HSM 09 079	
Safety ratings of complete system in acc. with EN 62061 respectively EN ISO 13849-1	Safety Integrity Level (SIL)	SIL 1 in acc. with EN 62061
	Performance Level (PL)	PL c in acc. with EN ISO 13849-1
	Category	Cat. 2 in acc. with EN ISO 13849-1
	DC [%]:	60 in acc. With EN ISO 13849-1
Safety ratings of the electronic device in acc. with EN ISO 13849-1	PFH _d [h ⁻¹):	6,61 x 10 ⁻⁷
	MTTF _d [a]:	88
	n _{op} [n/a]	8760
	CCF	95
	Mission time T _M [a]	20
Maximum clearance distance	50 m	25 m
Optical systems	1	
Safety-related tolerance of the systematically distancing accuracy	Maximum 9% (in accordance with diagram fig. 4.4.3)	
Safety-related tolerance of the distancing accuracy due to environmental influences	Additional 8% (by reason of environmental influences, e.g. fog, steam, smoke)	
Power supply / output or current consumption	(●: Option)	
230VAC ± 10 %	● / 10VA	
115VAC ± 10 %	● / 10VA	
42...48VAC ± 10 %	● / 10VA	
24VDC + 20 % / - 10 %	● / ~ 350mA	
Connection	2 x cable glands; terminal strip	
Switching outputs		
<i>Main contact (to switch off the crane movement)</i>	2 x relay NO contacts; supervised and force guided	
<i>Status message</i>	1 x relay NC contact	
<i>Pollution warning</i>	1 x relay change-over contact	

Fotoelektrik Pauly – light barriers

	CPV1037	CPV1037*01
Switching capacity		
<i>Min. switching current</i>	10 mA @ > 5 V	
<i>Main contact (to switch off the travel movement)</i>	AC1: 5 A @ 230 VAC AC15: 2 A @ 230 VAC	DC1: 6 A @ 24 VDC DC13: 1 A @ 24 VDC
<i>Status message</i>	AC1: 5 A @ 230 VAC AC15: 1 A @ 230 VAC	DC1: 6 A @ 24 VDC DC13: 1 A @ 24 VDC
<i>Pollution warning</i>	AC1: 6 A @ 250 VAC AC15: 2 A @ 250 VAC	DC1: 6 A @ 24 VDC DC13 ¹ : 1 A @ 24 VDC
<i>Electrcal life</i>	DC1: > 1 x 10 ⁶ @ max. switching capacity AC1, AC15, DC13:> 2 x 10 ⁵ @ max. switching capacity	
Switching rate	3 / s	
Access time	≤ 80 ms	
Switching displays		
<i>Switch indicator</i>	2 x LED green	
<i>Level indicator (for sighting reflector)</i>	4 x LED red (DIANA)	
Transmitted light	850 ... 880 nm, invisible	
Steady light resistance	> 80 k lux	
Operating mode	Alternating light, dynamic, continually self-testing	
Signal mode	Dark switching	
Housing	Cast aluminum	
Protection mode	IP65 – protection against dust and jets of water	
Weight	~ 3500 g (without adjustment flange)	
Operating temperature	- 25 °C ... + 60 °C, non-condensing	
Climatic conditions in acc. with EN 60721-3-3:1995, table 1	max. relative humidity (d): 95%; max. solar radiation (j): 700W/m ² ; Condensation (m): none; Wind-driven precipitation (n): none; Formation of ice and frost (including freeze-thaw) (p): none	
Special functions		
<i>Exterior test system</i>	The safety-related switching outputs will be switched off and the movement of the crane will be halted if there is insufficient detection capacity	
<i>Sabotage protection</i>	Covering of light barriers is detected and will lead to the switching off of the safety-related switching outputs and the crane movement will be halted	
<i>Pollution warning</i>	The light signal level is evaluated continuously	
Accessories		
<i>Reflectors</i>	<i>(intended use as per the clearance distance)</i>	
<i>4R100BL</i>	0.5 ... 25 m	1 ... 25 m
<i>4R100BLAF</i>	0.5 ... 25 m	1 ... 25 m
<i>18R100BL</i>	0.5 ... 50 m	1 ... 25 m
<i>18R100BLAF</i>	0.5 ... 50 m	1 ... 25 m
<i>Adjustment flange</i>	JF152S	

Regarding CPV1037*01: Device without optical sensing behaviour in range 1 to 6 m.

¹ With spark suppressor only, see Section 4.8

4. Operating instructions

4.1 Information on this technical description

These operating instructions contain information on the correct use of the CPV1037 distance monitoring system. They constitute an integral part in the scope of supply.

4.2 Device description

A distance monitoring system or collision protection system consists of a reflex light barrier and a reflector. With the CPV1037 single channelled distance monitoring system a specific distance is set. The distance is set using the triangulation principle.

The electronics of the reflex light barrier are housed in an enclosure with IP 65 protection. A protection roof protects the lens system of the reflex light barrier against external conditions, for example rain, snow or dust. The protection roof is fixed on the enclosure lid. For opening the lid, the protection roof can be folded up.

An adjustment flange is available for mounting the reflex light barrier. This enables fast and accurate assembly and alignment.

The external test unit generate continually defined light signals (infrared light), which impacts on the internal receiving unit through the receiving lens. The external test unit continuously simulates the light reflected by a reflector.

A highly dynamic signal processing procedure evaluates the rays of light pulses received. This evaluation means that the distance monitoring system is fail-safe, shock resistant, resistant to external light and stable.

When the set clearance distance is reached, the reflector on the opposite crane can be viewed. The view of the reflector and any internal component faults decisively alter the dynamic signal processing and accordingly stop the crane's movement. When farther clearance distance is reached, the crane completely stops (→ safe state).

The reflex light barrier continuously performs tests on its function using the highly dynamic signal processing procedure - "continually self-testing". Any worsening in visibility conditions or direct pollution of the lenses leads to weakening of the signal. Significantly weakened signals that could substantially impair the function are detected at an early stage and directly lead to stopping of the crane (→ safe state).

The high optical performance of the system means the distance monitoring system can be used for distances up to 50 m and still have very considerable reserves in terms of function.

Travel movement can be halted if the light barrier is made "blind" due to the lens being covered over at close range – "sabotage protection".

The integrated signal-emitting pollution evaluation is effective for the current reflector view and evaluates the current signal level. If the signal level on the active reflector view is too low the pollution is displayed via a signalling contact.

The requisite reflector plates on the reverse are available in different sizes. The format to be used for the reflector is determined by the clearance distance and the resultant triangulation angle.

For clearance distance	Reflector area (width x height)	Model
up to 25 m	400 mm x 100 mm	4R100BL(AF)
up to 50 m	900 mm x 200 mm	18R100BL(AF)

The reflector comprises a carrier plate with individually mounted reflector elements on it. The reflector elements are fastened with screw connections that cannot be loosened with conventional tools. Moreover, due to their design, the reflector elements cannot get be misplaced. The special design of the reflector plate means that the reflector elements are protected against strong pollution deposits and overflowing water. It is not possible to dismantle the reflector using conventional tools without damaging it.

4.3 Description of function

4.3.1 Triangulation triangle

The clearance distance is determined using the triangulation method. For this purpose, the high performance reflex light barrier must be aligned at an angle to the direction of movement of the crane towards the reflector affixed to the other crane. The right-angled triangulation triangle is formed as follows: *(when sighted from the light barrier)*

- from the distance between the two cranes – connecting line between the installation location of the light barrier and the left reflector edge = adjacent side to angle \angle and
- from the width of the reflector = opposite leg to the angle \angle and
- from the outer light cone from the reflex light barrier = hypotenuse of the right-angled triangle.

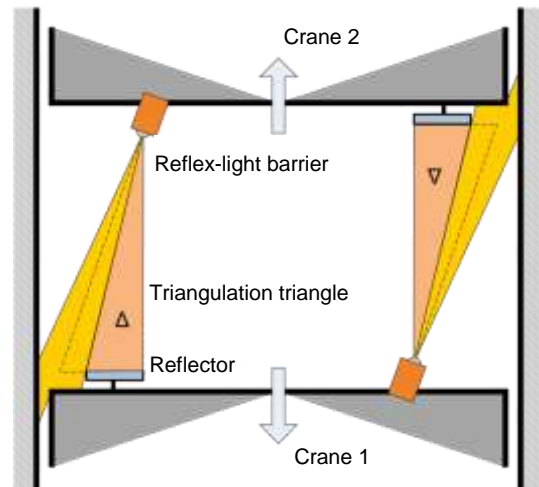

Fig.: 4.3.1

4.3.2 Approach movement

The reflex light barrier illuminates the edge of the reflector during the approach movement, when the set clearance distance is reached. The reflex light barrier sights the reflector. The switching outputs of the reflex light barriers are switched off – disconnected.

The safety-related switching outputs switched off and crane travel is brought to a halt! The cranes stop with a safe distance from each other.

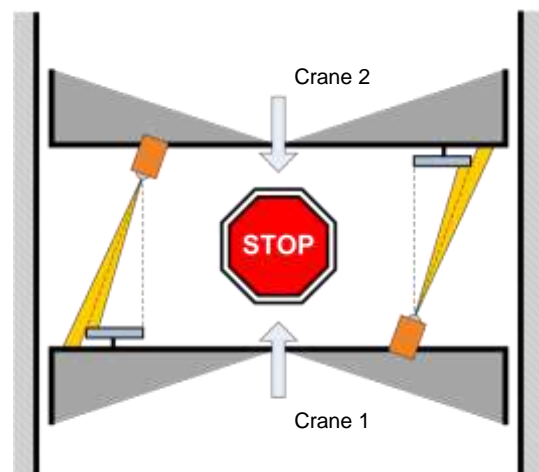

Fig.: 4.3.2

The level of the light signal depends on the degree of coverage by the light spot of the reflex light barrier on the reflector. Even very small amounts of cover lead to very high signal levels. This results in a signal level with extremely steep edges.

4.3.3 Continually self-testing

During the entire operation the light reflected by the reflector is reproduced by the external test unit. The external test unit generates a modulated light signal and shines through the receiver lens and onto the receiver. The modulated test signal received is evaluated by the highly dynamic signal processing procedure. In this manner, a functional check of all optical and electronic construction elements is conducted simultaneously. The light barrier performs self-tests continuously.

If the reflector is not sighted and if no optical or electronic faults are present, the NO contacts of two separate and mutually monitored switching relays for releasing the travel movement are switched on. The design has resulted in relays that are specially qualified. Positively driven contacts here ensure a high degree of reliability. The power via the contacts has to be limited by an overcurrent protection device.

4.3.4 Possible movement of the crane

Prerequisite: the reflector is undetected. The actual distance between the cranes is greater than the set clearance distance. The beams of the reflex light barrier goes past the reflector. There are no optical or electronic faults.

Effect: the crane is cleared for movement. Two safety-related relays are switched on and these signal the clearance for crane movement through the closed NO contacts. 2 green status LEDs are switched on directly with the relays and visualise the clearance for crane travel.

4.3.5 Movement of the crane is stopped

Prerequisite: the set clearance distance is reached during the approach travel. The reflector edge of the other crane moves into the beam of the reflex light barrier.

Effect: the reflex light barrier detects its emitted light signal and switches the two safety-related relays off. The green status LEDs darken. The travel movement is stopped.

REMARK:

Switching off the safety-related relays, depending on the task, can be used either to reduce the speed or stop the travel movement.

When used as intended, the system serves to halt the movement of the crane when approaching or when reaching the set clearance distance. For the abovementioned function 2 CPV1037 systems must be installed or the CPV1038 system must be deployed.

4.4 Pollution control function

4.4.1 Principle

Primarily, the photoelectric barrier monitors itself continuously, independent of the travel movements. The light signal level, which is sent from the external test unit through the receiver lens, is evaluated at all times. The weakening of a specific signal level due to contamination of this test device (see also example in section 4.4.2) leads initially to a pollution warning signal. If the pollution is not eliminated, and with the increasing pollution, the specific function signal is further weakened then this leads to the stopping of the travel movement and the safety-related switching relays is switched off.

In a secondary effect, the reflector signal level is evaluated with active reflector detection. The weakening of a specific signal level here also leads to a pollution warning signal.

The pollution on the external test unit of the light barrier will be much more sensitively evaluated than the pollution on the reflector.

The pollution warning signal is displayed with the “VK-relay”. The triggered relay means that there is a pollution which must be eliminated as soon as possible, where the location of the pollution should be derived from the circuit states of the VK-relay and the states of the safety-related relays (see also section 4.4.3).



An appropriate warning system should be triggered by the pollution warning relay to provide timely detection and removal of pollution to maintain system availability.

4.4.2 Pollution example

Dust precipitation on an external test unit which can lead to a Pollution warning signal and/or blocking of the system.

In case of cleaning of the reflex light barrier system, the pollution of lenses, external test unit and the reflector are to be particularly eliminated

For the cleaning procedure, please note in addition the chapter 5 on “Maintenance and cleaning” of the respective operating instructions.

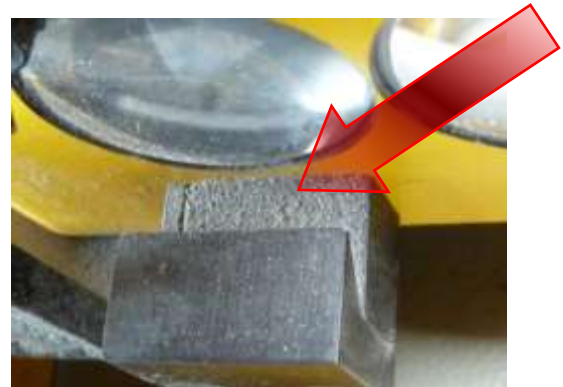

Fig.: 4.4.2

4.4.3 Pollution Indicator – meaning of the different circuit states

Table: 4.4.3

Drive action	Specific signal level external test unit	Specific signal level reflector view	Main-switching safety-related relay, circuit state	VK-relay circuit state	Meaning
Distance travel without reflector view	Higher than V-level	-	on	off	No pollution on LB
	Less than V-level, but higher than switch-off level	-	on	on	Pollution on LB – Prompt cleaning of light barrier and reflector required!
	Higher than switch-off level	-	off	on	Severe pollution on LB with transition into the secure status (stopping of the travel movement) – Immediate cleaning of light barrier and reflector required!
Approach travel with reflector view	-	Higher than V-level	on	off	No pollution on the reflector
	-	Less than V-level	off	on	Pollution on the reflector OR incomplete reflector view in the main switch-off mode

Legend / Explanations	
V-level	Pollution warning level (default setting by manufacturer)
LB	Light barrier
Pollution on the reflector	The Pollutants on the reflector has to be assumed if the limit distance has been reached and the corresponding safety-related relays switched off, AND after switching off the safety-related relays a sufficiently large distance has been driven which should generates a larger reflector signal level than the specific V-level itself.
Incomplete reflector view	A permanently very small reflector view with signal level less than V-level <u>BUT</u> signal level high enough to stop the travel movement.
Pollution Control signal	The pollution warning signal is displayed with a relay (VK). The relay is switched on with a delay of approx. 3s up to 5s if the current signal level does not exceed the specific V-level during this period. The pollution warning signal is reset immediately if the current signal level exceeds the V-level again.

4.5 Assembly

4.5.1 Horizontal arrangement of the triangulation triangle

Reflector (①) and light barrier-CPV1037 (②) are mounted horizontally. The triangulation triangle (③) then lies in the space horizontally. ② is mounted onto the crane using the JF152S adjustment flange. An imaginary line (④) that runs parallel to the crane track (⑤) connects ② on the right edge of the reflector (⑥). The angle (⑦) of the triangulation triangle should be selected such that the ② is pointing towards the left reflector edge when the limit distance is reached (⑧) (see also chapter on “adjustment”).

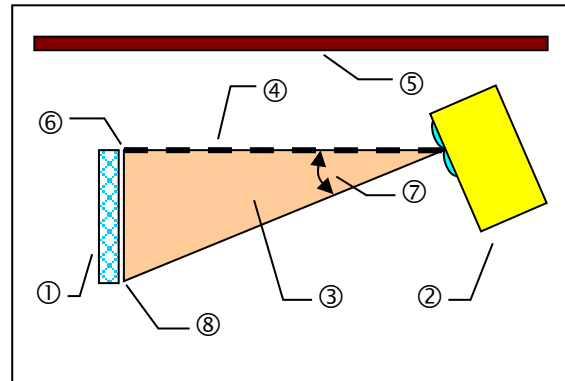

Fig.: 4.5.1-1: Example of a triangulation triangle clamped to the left

The triangulation triangles must be designed in such a way that the light barrier optics do not look into each other, directly or via reflections. Examples:

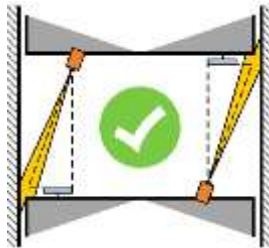

Fig.: 4.5.1-2: Proper arrangement

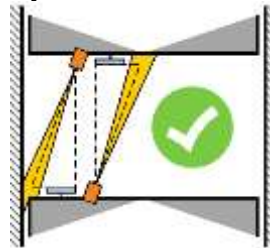

Fig.: 4.5.1-3: Proper arrangement

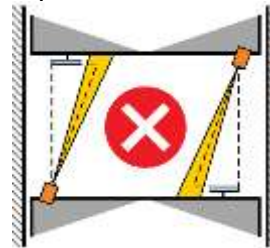

Fig.: 4.5.1-4: Wrong arrangement

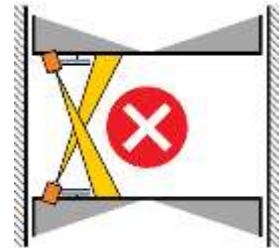

Fig.: 4.5.1-5: Wrong arrangement

Note to fig. 4.5 1-3: The distance between the applied outer edge of the device and the reflector must be at least 200mm.

The Reflector and CPV1037 must be mounted at the same height. This means that the middle of the reflector (①) must be positioned at the same height (⑩) as the middle of the lens system of CPV1037 (②). The height of both parts should be taken from a common reference point (⑨).

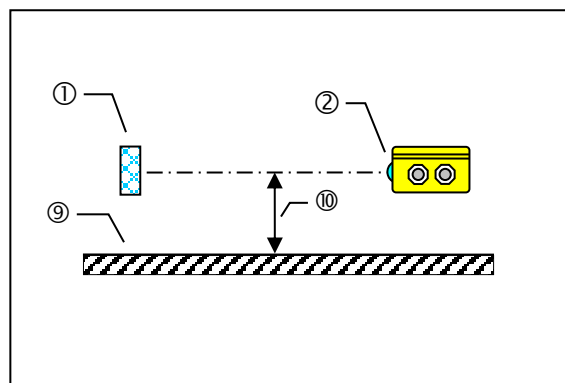

Fig.: 4.5.1-6



It is essential to ensure that the optical system can still view the reflector when both cranes have been moved together up to buffer distance!



Mount the reflector close to the edge of the crane bridge. Avoid blocking the visible area of the reflector.



The CPV-System should be installed near or on top of the End-carriage.

4.5.2 Distance monitoring accuracy

The clearance distance (①) is determined by the fixed beam angle set (Δ). The accuracy and the reproducibility of the clearance distance depend on the movement tolerances of the individual crane components. Horizontal lateral shifts or rotations of the crane bridges have a direct impact on the installation position of the reflex light barrier (②) or the reflector (③) and accordingly shorten or lengthen the clearance distance set.

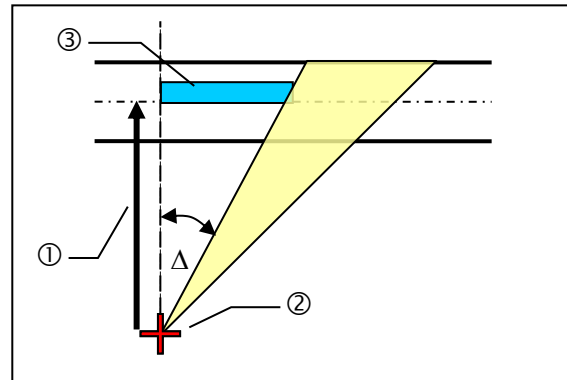

Fig.: 4.5.2-1: Set clearance distance

Lengthening the clearance distance

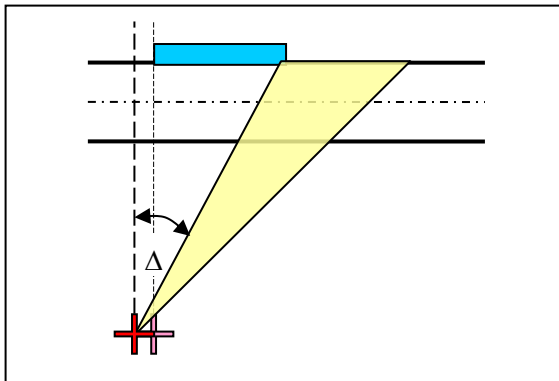

Fig.: 4.5.2-2: Shifting to the left

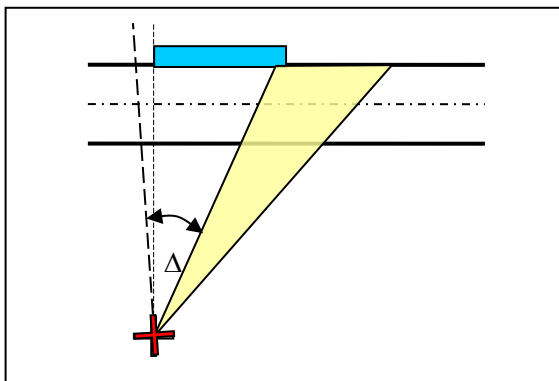

Fig.: 4.5.2-4: Rotation to the left

Shortening the clearance distance

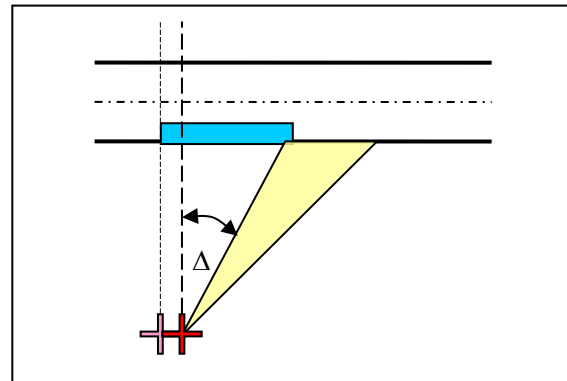

Fig.: 4.5.2-3: Shifting to the right

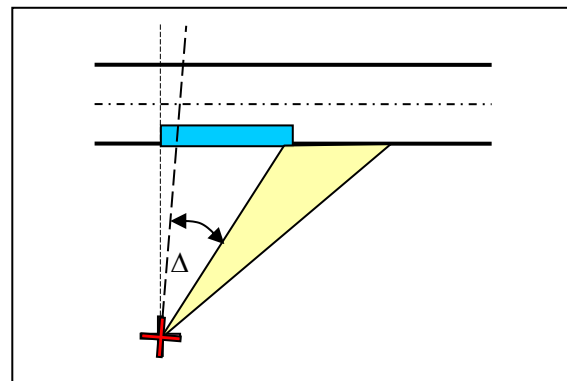

Fig.: 4.5.2-5: Rotation to the right



System-related movement tolerances in crane systems, crane/rail track and the associated impact on the switching behaviour of the distance monitoring system should be taken into consideration at the planning stage for the crane system and crane/rail track.

4.5.3 Taking the tolerances into consideration with respect to clearance distance

The very high performance of the system facilitates “tolerant” functional behaviour. However a certain tolerance in terms of distance behaviour must be taken into account for the very reason of this high performance in order for perfect, planned functional behaviour of the system to be guaranteed at all times in the long term (e.g. aging). For this reason the following possible tolerances must be taken into consideration from the start.

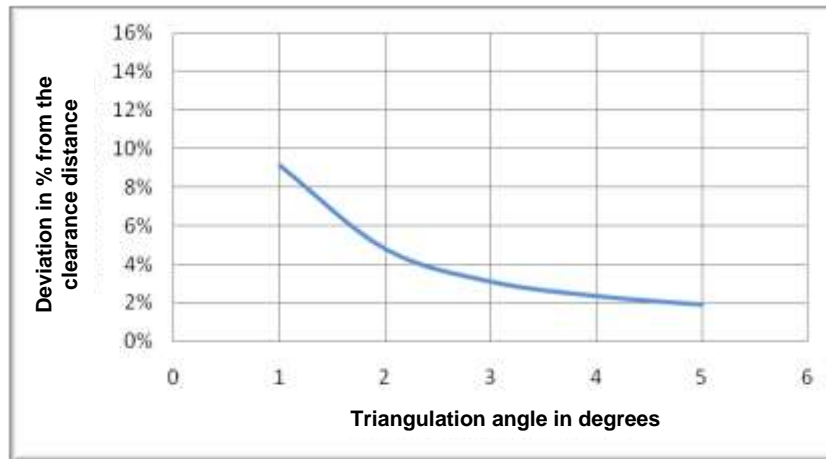

Fig.: 4.5.3: Tolerance in relation to the triangulation angle



The safety-related tolerances in the distances accuracy must be taken into account by adding them to the planned clearance distance.



In case of applications with environmental influences, e.g. excessive fog, excessive steam or excessive smoke, additionally 8% of the planned clearance distance must be considered

Case example with and without environmental influences:

Planned distancing = 15 m

Reflector width = 400 mm (crane reflector 4R100BL)

Calculated triangulation angle 1.5°

Tolerance in accordance with diagram fig. 4.5.3: 7% $\hat{=}$ 1,1 m















Additional tolerance because of environmental influences: 8% $\hat{=}$ 1,2 m

Minimum distancing to be set

without environmental influences = 16.1 m + movement tolerance.

with environmental influences = 17,3 m + movement tolerance.

4.6 Information on assembly

-  The mounting has to be done in such a way that a misalignment caused by mechanical vibration or bumps can be excluded. After finishing the fine alignment, the transducer benches have to be tightened with the fixing screws.
The adjustment flange has to be locked with the mounting surface. Drill a hole of 6mm diameter and 20mm length close to each fastening hole and pin the adjustment flange with the enclosed spring dowel sleeves.
-  The reflector must be installed in non-accessible areas or must be concealed.
-  The reflector should be protected from pollution by suitable measures e.g. a protective housing.
-  The light beams of the systems must not be interrupted e.g. obstructions or suspended objects. This must be taken into account at all events during assembly and operation of the system.
-  It is to be absolutely ensured that the optics of the distancing assembly still has a reflector view if both cranes have driven together to buffer separation distance!
-  When calculating the clearance distance the reaction time of the system must be taken into consideration as decisive parameter for the stopping path of the crane.
-  The set clearance distance must be tested and recorded.
-  The reflector centre on the other crane must be situated at the optical device (lens) level (see Fig. 4.5.1.6).
-  The devices on a crane and the adjacent crane must be mounted in such a way that their optical system do not look into each other (directly or via reflections), Any mutual influence must be excluded (see Fig.: 4.5.1-2...-5).
-  In contrast to the assembly location of the reflector, assembly of the light barrier (optoelectronics) must take place at the site where more pollution is to be expected.
-  The fixture of the CPV on the associated adjustment flange must be done by means of the provided fasteners.
-  The fastening of the reflector must take place using rivets, adhesive or welded connectors or using the screws supplied (safety screws with locking wedge), so that dismantling can only take place by destroying the fastening element.
-  During and after the adjustment, it must be ensured that the plastic (safety) inserted part of the lock nut engages on the thread and the springs are pretensioned.
-  Assembly may only be performed by a trained professional.
-  Triangulation angle $\Delta \geq 1^\circ$ to be set, see graph Fig.: 4.5.3: Tolerance in relation to the triangulation angle

4.7 Adjustment using the “light beam method”

Both cranes are moved together to the limit distance (①). For the adjustment the end of the reflector (③) is illuminated with a portable spotlight (②) placed close to the optical unit.

With the *lid of the device open*, it is possible to detect the reflection of the brightly illuminated reflector (⑤) on the transducer bench of the reflex light barrier (④).

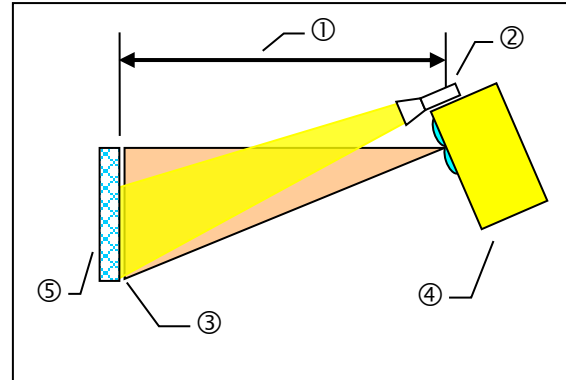

Fig.: 4.7-1

With the *lid of the device closed*, the reflector image can be observed from outside through the lens of the reflex light barrier using a special adjustment help (①).

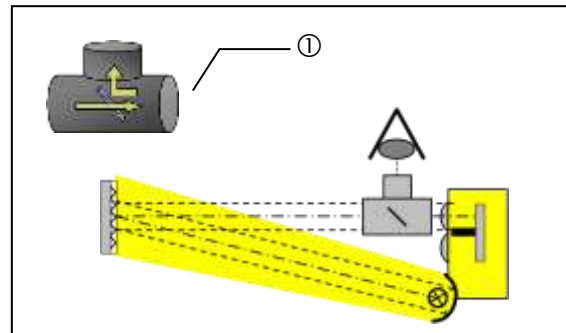

Fig.: 4.7-2

The vertical adjustment of the light barrier is set by means of the adjusting screw (①). The center of the reflector image should be adjusted to the height of the transmitter and receiver diode converter holes. The slotted mounting (②) can be used to rotate the device around the pivotal point (③) at the horizontal level.

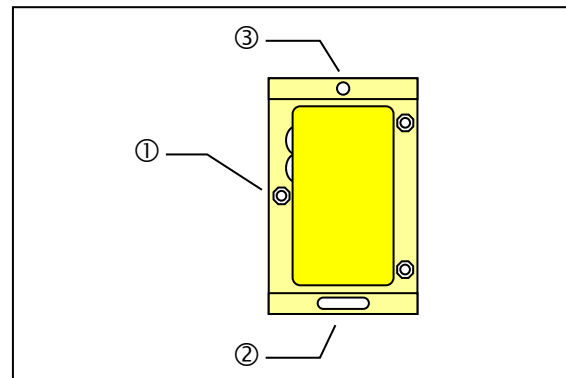

Fig.: 4.7-3

Graphical representation of the reflector image (③) on the transducer bench (①) during the adjustment procedure using the “light beam method”.

The light barrier is able to sight the reflector when the edge of the light image falls into the transmitter hole (④) or receiver hole (⑤).

If the light images of the reflector move in a straight line and horizontally across the transducer bench during the further approach travel, then the triangulation triangle is clamped absolutely horizontally. The dividing wall (②) prevents an optical short-circuit between transmitter and receiver.

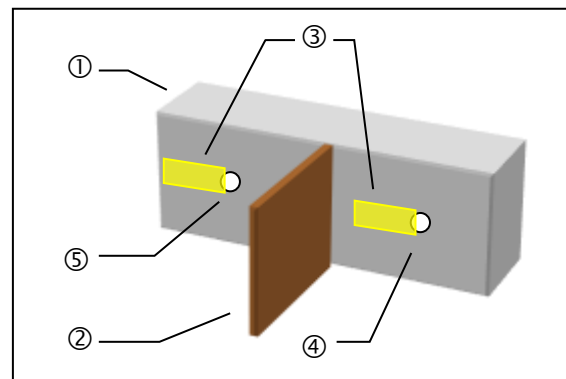

Fig.: 4.7-4: Representation of the reflector image for a triangulation angle clamped to the right.



See also the separate document „Setting Instructions CPV1037“

4.8 Electrical connection

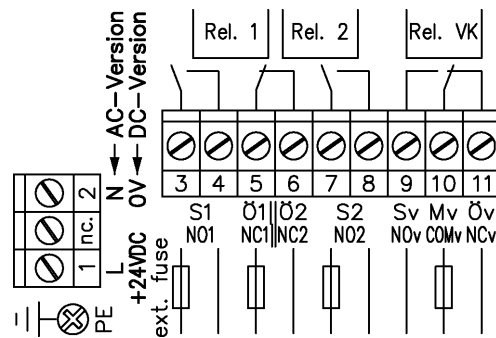

Fig.: 4.8: Connection diagram CPV1037

Table 4.8

Terminal block	Naming	Function
1	L1 / +24V DC	Supply voltage Version 'AC': L1 Version 'DC': + 24 V
2	N / 0V	Supply voltage Version 'AC': N Version 'DC': 0 V
PE	PE	Protective earth conductor
3 & 4	NO ₁	Make contact 1 (normally open contact), safety-related
5 & 6	NC ₁ NC ₂	Break contact
7 & 8	NO ₂	Make contact 2 (normally open contact), safety-related
9 ... 11	NO _v /COM _v /NC _v	Dirt accumulation changeover contact



It is only allowed to control the crane movement by using the normally open contacts NO₁ & NO₂.



The two separate normally open contacts NO₁ & NO₂ are provided to make a connection with a safety control device which may need two contacts for the safety function. If the following control unit does not need separated contacts then the normally open contacts NO₁ & NO₂ has to be connected per system in series.



The follow-up circuit for the safety-related shutdown of the travel movement must take into account the relevant product standard for the applicable crane type, e.g. EN 15011.



The external power supply has to fulfil the rules for low voltage with safe isolation (SELV, PELV) in accordance with EN 60204-1.



A protective earth connection is essential for protection against electric shock from exposed conductive parts.



It is not allowed to use the normally closed contacts NC₁||NC₂ also the change-over contacts NO_v/COM_v/NC_v for safety purposes.



The contacts NC₁||NC₂ and NO_v/COM_v/NC_v can be used for signalling purposes only just like a warning light or a warning flashlight.



To prevent any contact bonding a fuse corresponding to the maximum switching capacity of the utilization category has to be connected in line with each output contact (see chapter 3).



For switching inductive loads just like relays or contactors a spark suppressor has to be connected parallel to the inductive load.

AC: Spark suppressor with RC-module

DC: Spark suppressor with flyback diode

Notice: Spark suppressor modules must not connected parallel to the output switches!

4.9 Applicable documents

Table 4.9

Indenture number	Model	Document type	Description	Document
5259	CPV1037	Data sheet	Optical Anti-Collision Device	E_52591.pdf
5259M01	CPV1037*01	Data sheet	Optical Anti-Collision Device	E_525911.pdf
5259	CPV1037	Operating instructions	This document	E_52592.pdf
5259M01	CPV1037*01	Operating instructions	This document	E_52592.pdf
5259	CPV1037	Setting instructions	Quick Guide Mounting & Adjustment	E_525928.pdf
5259M01	CPV1037*01	Setting instructions	Quick Guide Mounting & Adjustment	E_525928.pdf
6801	4R100BL	Data sheet	Reflector for 25 m distance	E_68011.pdf
6801A01	4R100BLAF	Data sheet	Reflector for 25 m distance, anti-fogging version	E_68011.pdf
6802	18R100BL	Data sheet	Reflector for 50 m distance	E_68021.pdf
6802A01	18R100BLAF	Data sheet	Reflector for 50 m distance, anti-fogging version	E_68021.pdf
8683	JF152S	Data sheet	Adjustment flange for CPV1037 and CPV1037*01	E_86831.pdf
7111	JH1	Data sheet	Adjustment help	E_71111.pdf

5. Maintenance and cleaning

The optical surfaces and inspection of limit distances should only be performed by qualified technical personnel.

- a. Depending on the amount of pollutants e.g. dust accumulation in the system, the safety function and the set clearance distance of the system must be checked by moving the cranes together. The inspection interval depends on the expected degree of pollution. A suitable time interval for regular checking must be determined by the user and must be strictly adhered to. The minimum requirement is the functional check at the start of work to check the system's safety function by moving the cranes together (daily functional check, see section 2.4).
- b. Depending on the amount of pollution occurring in the system, the optical surfaces of the distancing device has to be cleaned in the fixed time interval (see "a")
In addition to the lenses of the device the optical surfaces also include the reflector

A soft, fluff-free cloth moistened with water should be used for cleaning. If required, a very small quantity of conventional washing-up liquid can be added to the clean water.



Do not use any cleaning agents containing alcohol or other solvents because they can ruin the safety function!



Avoid scratching the lenses and reflectors.

A functional test should be carried out on the distance monitoring system after each cleaning procedure. This should include a check of the disconnection function at the fixed limit distances. If required, the distance monitoring system should be reset to the fixed limit distances.

6. Contents of the EU Declaration of Conformity

EU DECLARATION OF CONFORMITY

Manufacture's name and Authorised representative for technical documentation:

Fotoelektrik Pauly GmbH
Wahrbrink 6
59368 Werne
Germany

We, Fotoelektrik Pauly GmbH, hereby declare that the product in the following

Generic denomination, function: **Optical Anti-Collision Device**
Model, type, commercial name: **CPV1037, CPV1037*01, CPV1038, CPV1038*01**
Serial number range: ...

in it's conception, construction and form put by us into circulation, is in accordance with the EC machinery directive 2006/42/EC.

The product may only be put into operation by competent personnel acting in compliance with the supplied documentation. In particular, it is mandatory to observe the safety and installation instructions and the instructions for the use in accordance with the intended purpose. This declaration is no longer valid if the Product is modified without our consent.

Additionally applied directives as well as harmonized standards:

2014/30/EU	EMC directive
EN ISO 13849-1:2016-06 EN ISO 13849-2:2013-02	Safety of machinery – Safety-Related Parts of Control Systems
EN 62061:2016-05	Safety of machinery – Functional safety of safety-related electrical, electronic and programmable electronic control systems

Notified body. – No 0393

DGUV Test
Prüf- und Zertifizierungsstelle Hebezeuge, Sicherheitskomponenten und Maschinen
Fachbereich Holz und Metall
Kreuzstraße 45
40210 Düsseldorf
Germany

Certificates:

EC-Type Examination Certificate: HSM 09 079

Source

D_5259Konfo.pdf

7. Decommissioning

The device must be correctly disposed of at the end of its service life. When decommissioning please observe the local laws on the disposal of electronic equipment.

8. Spare parts

Table 8

Indenture number	Model	Description	Power supply
5259	CPV1037	Optical Anti-Collision Device intended for clearance distances of up to 50 m	24VDC
			42 ... 48VAC
			115VAC
			230VAC
5259M01	CPV1037*01	Optical Anti-Collision Device intended for clearance distances of up to 25 m	24VDC
			42 ... 48VAC
			115VAC
			230VAC
6801	4R100BL	Reflector for 25 m distance	
6801A01	4R100BLAF	Reflector for 25 m distance, anti-fogging version	
6802	18R100BL	Reflector for 50 m distance	
6802A01	18R100BLAF	Reflector for 50 m distance, anti-fogging version	
8683	JF152S	Adjustment flange for CPV1037 and CPV1037*01	
7111	JH1	Adjustment help	

Order data:

Model; power supply

Example:

CPV1037 /230VAC

D-59368 Werne, 2020-02-19

* 5259__*

SRC: E_52592-2020-30.docx

Fotoelektrik Pauly GmbH

The ownership and design of devices and their electronics are the intellectual property of "Firma Fotoelektrik Pauly GmbH". Internal wiring diagrams can therefore not be provided for copyright reasons. Subject to technical changes and errors. Reproductions or copies of excerpts of this document are only permitted with the approval of "Firma Fotoelektrik Pauly GmbH" and with specification of the source. Infringements shall be liable to prosecution.